

Meridian DSP Loudspeaker User Guide

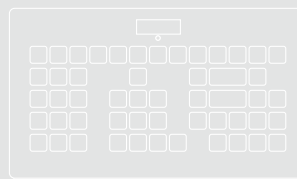

Important safety instructions

- Read the instructions.
- Keep these instructions.
- Follow all instructions.
- Do not use this apparatus near water.
- Clean only with a dry cloth.
- Install only in accordance with the manufacturer's instructions.
- Refer all servicing to approved service personnel.
- Do not disassemble – no user-servicable parts inside.

This apparatus has been designed with Class 1 construction and must be connected to a mains socket outlet with a protective earthing connection (the third grounding pin).

The apparatus may be isolated from mains power either by unplugging the power connector from the rear of the unit, or by unplugging the connector at the opposing end of the power cord or cable from its supply outlet. As a result, either or both of these connectors should remain accessible.

Safety warnings

WARNING: TO REDUCE THE RISK OF FIRE OR ELECTRIC SHOCK, DO NOT EXPOSE THIS APPARATUS TO RAIN OR MOISTURE.

- Do not expose the unit to dripping or splashing.
- Do not place any object filled with liquid, such as a vase, on the unit.
- Do not place naked flame sources, such as lighted candles, on the unit.

To avoid overheating

- Leave at least 10cm around the equipment to ensure sufficient ventilation.

Do not position the unit:

- In direct sunlight.
- Near heat sources, such as a radiator.
- Directly on top of heat producing equipment.

To avoid interference

Do not position the unit:

- Near strong electrical or magnetic radiation, such as near a power amplifier.

Radio interference

FCC Warning: This equipment generates and can radiate radio frequency energy and if not installed and used correctly in accordance with our instructions may cause interference to radio communications or radio and television reception. It has been type-tested and complies with the limits set out in Subpart J, Part 15 of FCC rules for a Class B computing device. These limits are intended to provide reasonable protection against such interference in home installations.

EEC: This product has been designed and type-tested to comply with the limits set out in EN55013 and EN55020.



Contents

Introduction	1	Using the DSP loudspeakers	27
Meridian DSP loudspeakers	2	Selecting a source	28
Sample configurations	4	Changing the display	29
DSP5200 and DSP5200HC	7	Adjusting the volume	30
Unpacking	8	Changing the treble, bass, or phase	31
Specifications	10	Changing the listening position	32
DSP5500, DSP5500HC, and DSP5500C	11	Configuring the DSP loudspeakers	33
Unpacking	12	Choosing standard settings	34
Specifications	14	Specifying information about your system	36
DSP7200 and DSP7200HC	15	Configuring the sources	37
Unpacking	16	Configuring the setup options	38
Specifications	18	Troubleshooting	41
Connecting up the DSP loudspeakers	19	Troubleshooting	42
Connecting the loudspeakers	20	Cleaning	43
Connecting to other equipment	21	Service and guarantee	44
Positioning the digital loudspeakers	25	Index	45

Copyright and acknowledgements

Sales and service in the UK

Meridian Audio Ltd
Latham Road
Huntingdon
Cambridgeshire
PE29 6YE
England

Tel (01480) 445678
Fax (01480) 445686

Sales and service in the USA

Meridian America Inc
8055 Troon Circle
Suite C
Austell
GA30168-7849
USA

Tel (404) 344 7111
Fax (404) 346 7111

<http://www.meridian-audio.com>

Designed and manufactured in the UK

Meridian Audio Ltd
Latham Road
Huntingdon
Cambridgeshire
PE29 6YE
England

Copyright © 2002-2010 Meridian Audio Ltd.
Part no: DSPU/8 (P86499)

Meridian Digital Theatre, Meridian Lossless Packing,
MHR and MLP are registered trademarks of
Meridian Audio Ltd.

MHR: This product incorporates copyright protection technology covered by certain patent applications and intellectual property of Meridian Audio Ltd. This technology is provided for the express purpose of securely containing copyright audio within the Meridian System only. Reverse engineering or circumvention of this protection is strictly prohibited.

This guide was produced by:
Human-Computer Interface Ltd,
<http://www.interface.co.uk>

Introduction

Welcome to the Meridian DSP loudspeaker range.

This user guide provides full information about using the DSP loudspeakers in conjunction with your other equipment, to achieve the superb results you can expect from them.

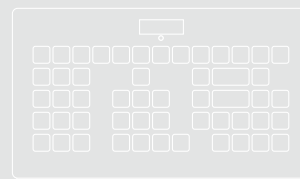

Meridian DSP loudspeakers

Meridian DSP loudspeakers represent the fruits of more than 25 years of continuous development of loudspeakers as musical instruments. The finest materials and state-of-the-art design are combined to create what we believe is the ultimate range of home loudspeakers.

Digital Signal Processing

Digital Signal Processing, or DSP, is a technique pioneered by Meridian in hi-fi products for achieving extremely accurate reproduction of audio signals using high-precision mathematical processing.

DSP allows sophisticated processing to be performed without any of the cumulative noise or degradation that inevitably occurs, even with high-quality analogue circuitry. In addition, the signal improvement techniques incorporated in the Meridian DSP loudspeakers would be virtually impossible to implement in the analogue domain.

The Meridian DSP loudspeakers take advantage of DSP for several different functions:

- To remove timing variations from the incoming digital signals (de-jittering).
- To split the audio frequency band between bass, mid-range, and treble drivers (crossover).
- To perform filtering or adjustment of the frequency response; eg treble or bass.
- To provide volume control to 48-bit precision.
- To provide digital protection of the loudspeakers against high-level low-frequency transients.
- To perform electronic equalisation.

If you are using the Meridian DSP loudspeakers with a digital source, such as CD or DVD, the signals remain in digital form until the last possible stage.

DSP loudspeaker drivers

Each DSP loudspeaker uses multiple high-efficiency long-throw custom bass drive units.

Each treble unit is a very high quality 25mm (1") Meridian piston in a short horn, using an aluminium dome with a silver voice-coil. It is extremely well matched to the woofers, and also tonally very compatible with the other drivers employed in the Meridian range.

Power amplifiers

The speakers are driven by multiple independent high-power, low-feedback power amplifiers. The combination of idealised magnetic design, careful star earthing, and very fast output devices gives the amplifiers extremely low noise, high detail, and fast bass.

The whole electronic assembly is supplied from substantial toroidal transformers feeding high-quality, audiophile-grade capacitors.

Cabinet

Each DSP loudspeaker is carefully designed with internal bracing and damping to give incredibly low levels of cabinet resonance, resulting in low coloration and excellent mid-range transparency.

The DSP5200 and DSP5200HC are constructed using veneered plywood, braced and resin damped to produce an ultra-rigid cabinet.

The DSP5500, DSP5500C, and DSP5500HC are constructed using thick veneered MDF sides bolted through a 1.5mm steel plate onto the main cabinet, giving extremely low levels of cabinet resonance and excellent bass-mid isolation.

The DSP7200 cabinet is fabricated from curved pressure-laminated panels, using multiple layers of selected woods and metal to achieve high stiffness and damping. Its narrow tapered shape gives optimum

dispersion over a wide listening area. Each cabinet stands on three adjustable machined feet which can be fitted with spikes or skids.

Mounting options

In addition to the main vertical speakers, designed for use as the left/right speakers in a system, each model includes a single horizontal centre and/or a single vertical centre, designed for use as the centre speaker in a surround system.

The DSP5200HC, DSP5500HC, and DSP7200HC are horizontal centre versions, designed for use either above or below a television.

The DSP5500C is a vertical version, designed for use as a centre speaker, and it uses fully shielded drive units so they it be placed next to a television without interference.

Meridian High Resolution (MHR)

All Meridian DSP loudspeakers support Meridian High Resolution (MHR), to allow you to connect to other MHR-compliant Meridian products to take advantage of high-rate audio sources, and provide the additional benefits of lower jitter and improved sound quality on all sources.

MHR is a proprietary secure encoding format that uses encryption and anti-copy methods to provide a secure copyright protection environment, and allow the secure transfer of audio streams within a Meridian-only system for playback only.

Meridian Comms

Meridian DSP loudspeakers are part of the Meridian family of advanced digital, analogue, and video components. These incorporate a sophisticated communications link, called Meridian Comms, to allow you to control any combination of units using a single

remote, and ensure that they will work together as a fully integrated system.

The Meridian SpeakerLink connectors provide both Meridian Comms control and two-channel balanced digital audio in a single convenient SpeakerLink lead.

Meridian Comms also allows you to extend your hi-fi system into two or three rooms, with the ability to control the sources in one room from the controller in another room.

The following page shows two recommended configurations based on the Meridian DSP loudspeakers to illustrate the flexibility of Meridian components.

Available accessories

Other applications, and some advanced features, may require one or more of the following accessories, which can be purchased from your Meridian dealer:

- MSR+ remote.
- Interconnecting leads.
- AC11 SpeakerLink Hub, to allow interconnection between newer products with SpeakerLink connectors, and products with Meridian BNC Comms or Meridian DIN Comms connectors.

Sample configurations

Meridian Digital Theatre™

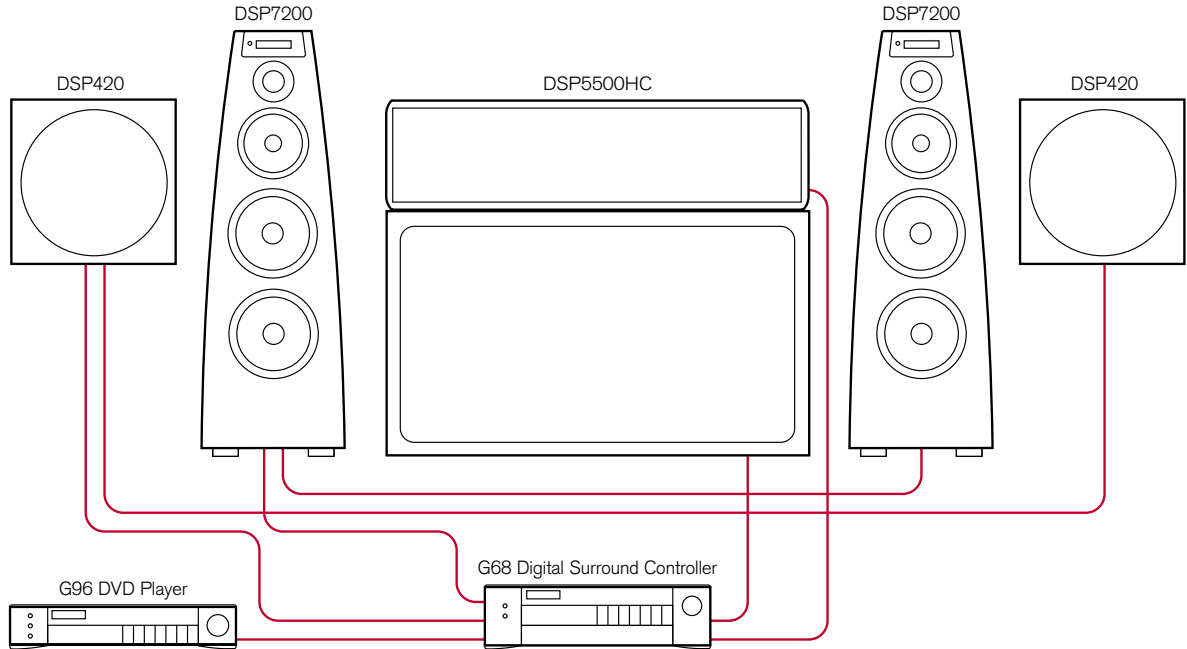

Up to seven Meridian DSP loudspeakers can be used in conjunction with a Meridian Surround Processor, such as the G68 Digital Surround Controller, to create a digital surround system with superb music and cinema sound.

The G96 DVD Player is an ideal source for use with DSP loudspeakers. It allows you to play audio CDs and DVD-Video discs, with the audio kept in digital form until the last possible stage.

Meridian Digital Music System

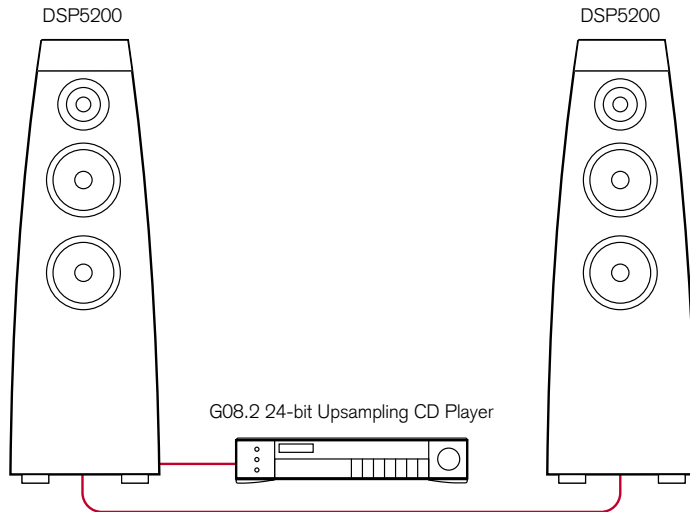

Meridian DSP loudspeakers include DSP volume and tone controls, and can be connected directly to up to two digital sources, such as the G08.2 24-bit Upsampling CD Player, to create an extremely compact high-quality music system.

DSP5200 and DSP5200HC

This chapter explains how to unpack and install the DSP5200 and DSP5200HC, and gives specifications.



Unpacking

Before you begin installation you should ensure that your DSP loudspeakers are the correct voltage for your local AC supply. If they are not, do not try to install them, and contact your dealer.

You should not make any connections to the DSP loudspeakers, or to any other component in your system, while the AC power supply is connected and switched on.

Care when unpacking

Take great care when unpacking or repacking the DSP loudspeakers that you do not put undue pressure on the face containing the drive units, as they may be damaged if pressed.

Components

Each pair of DSP loudspeakers is supplied with the following components:

- The DSP loudspeakers complete with grilles.
- A hex wrench (3mm) for the drive units.
- Eight screw-in feet with retractable spikes (DSP5200 only).
- Eight rubber bumpons (DSP5200HC only).
- One power cord per speaker.
- This user guide.

If any of these items is missing please contact your dealer. We suggest that you retain the packaging carefully for maximum protection in transit.

Caution

Meridian Audio has taken every care in the design, assembly, finishing and packing of this product. Some models include a high-gloss finish, which is achieved by painting up to five coats of polyester lacquer onto the plywood, each one hand polished.

Due to the product size and high technology cabinet construction, small marks on the lacquer surface may

be visible when unpacked. These small marks can usually be removed as described in **Cleaning**, page 43.

It is the nature of all lacquer finishes to shrink over time. This is unavoidable and may result in cabinet joint lines becoming visible.

Meridian Audio has supplied products using lacquer finishes for many years and we are confident that when carefully used your product will return a lifetime's enjoyment.

To fit the feet (DSP5200 only)

The feet ensure that the loudspeakers have a stable base, and can be adjusted to allow for uneven floors. Use the spikes for carpeted floors; they are designed to penetrate the pile without damaging or flattening the carpet. Retract the spikes for solid floors.

Each DSP loudspeaker needs four feet, fitted as follows:

- Insert the spike into the foot so that the nut engages in the hexagonal recess in the bottom of the foot, and screw each spike into the threads on the bottom of the loudspeaker. Do not fully tighten the lock nuts at this stage.
- On solid floors retract the spike so it does not extend below the foot cap.
- When all four feet have been fitted, carefully set the DSP loudspeakers upright in their playing positions and remove the rest of the packaging.
- On carpeted floors, adjust the spikes until the speakers are stable, and then tighten the lock nuts using the feet as wrenches. If you need additional length on the spikes you can remove the feet and use the spikes and lock nuts on their own.

To fit the rubber bumpons (DSP5200HC only)

- Attach four bumpons to the underside of each speaker, using the self-adhesive pads.

Tightening the drive units

The DSP loudspeakers typically take about two weeks of normal use for the drive units to settle. It is therefore recommended that you tighten the mounting bolts on each drive unit every few days during this period. Tighten the bolts in symmetrically opposite pairs using the 3mm hex wrench supplied.

You should then check and if necessary re-tighten the drive units every few years.

Removing the grilles

The grilles are deliberately designed to fit tightly to avoid vibration during operation, and they should be removed using the following procedure to avoid damaging the loudspeaker.

The grille consists of elastic material stretched tightly over a plastic ring. The plastic ring includes two indentations at the three o'clock and nine o'clock positions, which you can locate by gently depressing the grille fabric.

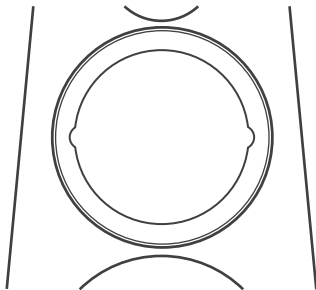

Hold the ring by one of the indentations by depressing the grille fabric with your thumb, and then wiggle the

ring forwards until it comes free of the speaker. The grille fabric is very resilient and any depressions will soon disappear.

Note: On no account attempt to remove the grille with a hard object, or attempt to lever it out from the outside edge, as you will damage the edge of the speaker surround and the grille itself.

Specifications

Connections

- Digital co-axial input and output.
- Meridian BNC Comms input and output.
- Meridian SpeakerLink (RJ45) input and output, providing balanced digital and Meridian Comms.

Digital formats

- 44.1–96kHz. FIFO locks at 44.1, 48, 88.2, or 96kHz \pm 150ppm.
- PCM using IEC958, or MHR connection support with auto-detection.

Signal processing

- 1 x Motorola 56367 running at 150MHz.
- 4 x 24-bit Multi-bit delta-sigma DACs with 128x oversampling.
- Crossover linear-phase \pm 30° at 2.6kHz.

Output stages

- Power amplifiers: Complementary bipolar design, with output-stage error correction and twin loop design.
- Bass: 2 x 75W.
- Treble: 75W.

Acoustic

- 2½ way.
- Ported bass enclosure.
- Isolated mid enclosure.
- Bass drive unit: 2 x 160mm (6") custom polypropylene driver using phase plug.
- Treble drive unit: 1 x 25mm (1") Meridian piston in short horn, aluminium dome with silver voice-coil.

Characteristics

- Distortion typically <0.02% up to full power at all frequencies.
- Noise and hum <-94dB at all volume settings.
- Acoustic output typically >108dB spl @ 1m.
- Acoustic noise <15dB spl @ 1m.
- Frequency response in room response within 3dB, 35Hz-20kHz.

Cabinet

- Entire speaker manufactured from interlaminated panels.
- Individually covered grilles for bass units.
- Finished in black or silver high-gloss lacquer, satin Santos rosewood, natural stain maple, black ash, or cherry.
- 8-character display with system lights.
- DSP5200: 300mm x 903mm x 356mm (11.8" x 35.6" x 14.0") (W x H x D).
- DSP5200HC: 735mm x 201mm x 267mm (29.0" x 7.9" x 10.5") (W x H x D).
- 35kg (77lb) each.

Power

- 100-125; 200-250V AC 50-60Hz.
- 20VA standby; 600VA max.

Meridian Audio reserves the right to amend product specifications at any time.

DSP5500, DSP5500HC, and DSP5500C

This chapter explains how to unpack and install the DSP5500, DSP5500HC, and DSP5500C, and gives specifications.

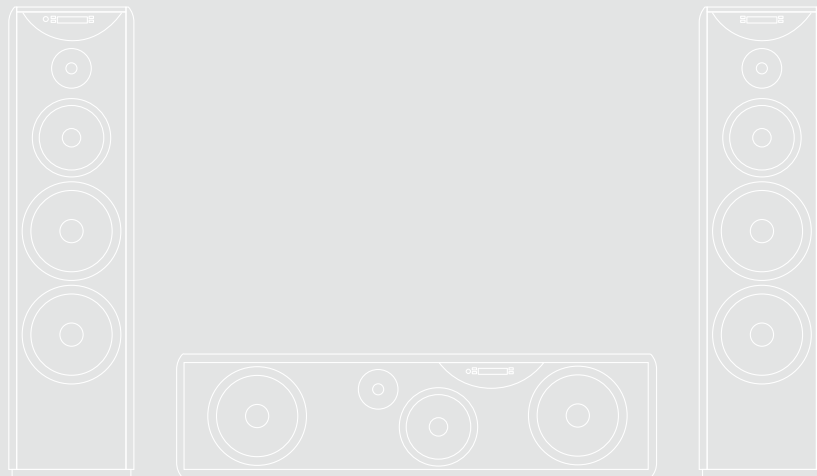

Unpacking

Before you begin installation you should ensure that your DSP loudspeakers are the correct voltage for your local AC supply. If they are not, do not try to install them, and contact your dealer.

You should not make any connections to the DSP loudspeakers, or to any other component in your system, while the AC power supply is connected and switched on.

Care when unpacking

Take great care when unpacking or repacking the DSP loudspeakers that you do not put undue pressure on the face containing the drive units, as they may be damaged if pressed.

Components

Each pair of DSP loudspeakers is supplied with the following components:

- The DSP loudspeakers complete with grilles.
- A hex wrench (3mm) for the drive units.
- A hex wrench (8mm) for the side panels.
- Eight screw-in spikes with lock nuts and protectors together with a wrench for fitting them (DSP5500 and DSP5500C only).
- Eight rubber bumpers (DSP5500HC only).
- One power cord per speaker.
- This user guide.

If any of these items is missing please contact your dealer. We suggest that you retain the packaging carefully for maximum protection in transit.

To fit the feet (DSP5500 and DSP5500C only)

The feet ensure that the loudspeakers have a stable base, and can be adjusted to allow for uneven floors. Use the spikes for carpeted floors; they are designed to penetrate the pile without damaging or flattening the carpet. Use the protectors for solid floors.

Each DSP loudspeaker needs four feet, fitted as follows:

- Fit a lock nut to each foot, leaving about 2mm of thread between the lock nut and foot.
- Screw each foot into the threads on the bottom of the loudspeaker. Do not fully tighten the lock nut at this stage.
- On solid floors fit the protectors over the spikes.
- When all four feet have been fitted, carefully set the DSP loudspeakers upright in their playing positions and remove the rest of the packaging.
- Adjust the feet until the speakers are stable, and then tighten the lock nuts.

To fit the rubber bumpers (DSP5500HC only)

- Attach four bumpers to the underside of each speaker, using the self-adhesive pads.

Tightening the drive units

The DSP loudspeakers typically take about two weeks of normal use for the drive units to settle. It is therefore recommended that you tighten the mounting bolts on each drive unit every few days during this period. Tighten the bolts in symmetrically opposite pairs using the 3mm hex wrench supplied.

You should then check and if necessary re-tighten the drive units every few years.

Removing the grilles

The DSP5500 grille frame has been designed to be as acoustically transparent as possible, and is quite fragile. When removing the grille, ease it carefully off by hand from the bottom and sides, avoiding excessive bending of the frame.

Specifications

Connections

- Digital co-axial input and output.
- Meridian BNC Comms input and output.
- Meridian SpeakerLink (RJ45) input and output, providing balanced digital and Meridian Comms.

Digital formats

- 44.1–96kHz. FIFO locks at 44.1, 48, 88.2, or 96kHz \pm 150ppm.
- PCM using IEC958, or MHR connection support with auto-detection.

Signal processing

- 2 x Motorola 56303 running at 80MHz.
- 4 x 24-bit Multi-bit delta-sigma DACs with 128x oversampling.
- Crossover linear-phase \pm 30° at 200Hz and 2.6kHz.

Output stages

- Power amplifiers: Complementary bipolar design, with output-stage error correction and twin loop design.
- Bass: 2 x 75W.
- Mid: 75W.
- Treble: 75W.

Acoustic

- 3 way.
- Ported bass enclosure.
- Isolated mid enclosure.
- Bass drive unit: 2 x 200mm (8") high-efficiency long-throw custom drivers.
- Mid drive unit: 1 x 160mm (6") custom polypropylene driver using phase plug.
- Treble drive unit: 1 x 25mm (1") Meridian piston in short horn, aluminium dome with silver voice-coil.

Characteristics

- Distortion typically <0.01%, or <0.02% up to full power at all frequencies.
- Noise and hum <-94dBr at all volume settings.
- Acoustic output typically >111dB spl @ 1m.
- Acoustic noise <15dB spl @ 1m.
- Frequency response in room response within 3dB, 28Hz-20kHz.

Cabinet

- Thick MDF side panels sandwiched around steel plates for maximum damping across all frequencies.
- Steel plates give magnetic shielding.
- Side panels available in black ash and rosewood.
- Separate mid-range enclosure built into main cabinet.
- 8-character display with system lights.
- DSP5500 and DSP5500C: 284mm x 1100mm x 450mm (11.2" x 43.3" x 17.7") (W x H x D).
- DSP5500HC: 1100mm x 285mm x 415mm (43.3" x 11.2" x 16.3") (W x H x D).
- 65kg (143lb) each.

Power

- 100-125; 200-250V AC 50-60Hz.
- 20VA standby; 600VA max.

Meridian Audio reserves the right to amend product specifications at any time.

DSP7200 and DSP7200HC

This chapter explains how to unpack and install the DSP7200 and DSP7200HC, and gives specifications.

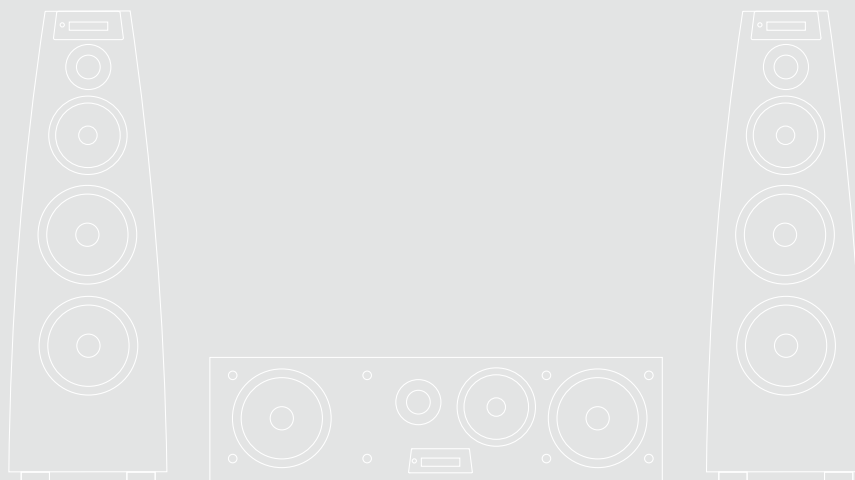

Unpacking

Before you begin installation you should ensure that your DSP loudspeakers are the correct voltage for your local AC supply. If they are not, do not try to install them, and contact your dealer.

You should not make any connections to the DSP loudspeakers, or to any other component in your system, while the AC power supply is connected and switched on.

Unpacking

The unpacking instructions are provided on a separate leaflet enclosed with the speakers. Please refer to this before proceeding.

Care when unpacking

Take great care when unpacking or repacking the DSP loudspeakers that you do not put undue pressure on the face containing the drive units, as they may be damaged if pressed.

Components

Each pair of DSP loudspeakers is supplied with the following components:

- The DSP loudspeakers complete with grilles.
- A hex wrench (3mm) for the drive units.
- One power cord per speaker.
- This user guide.

If any of these items is missing please contact your dealer. We suggest that you retain the packaging carefully for maximum protection in transit.

Caution

Meridian Audio has taken every care in the design, assembly, finishing and packing of this product. The high gloss finish on parts of the cabinet is achieved by painting up to five coats of polyester lacquer onto the plywood, each one hand polished.

Due to the product size and high technology cabinet construction, small marks on the lacquer surface may be visible when unpacked. These small marks can usually be removed as described in Cleaning, page 43.

It is the nature of all lacquer finishes to shrink over time. This is unavoidable and may result in cabinet joint lines becoming visible.

Meridian Audio has supplied products using lacquer finishes for many years and we are confident that when carefully used your product will return a lifetime's enjoyment.

Connecting the cables (DSP7200 only)

Connections to each loudspeaker are made to the input/output panel, which is located at the base of the loudspeaker to the rear.

Lead all the cables neatly through the slot in the base of the cabinet:

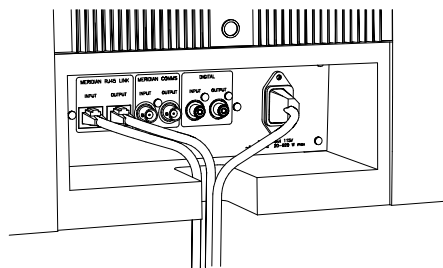

Finally fit the cover plate into position, concealing the input/output panel and connections.

Tightening the drive units

The DSP loudspeakers typically take about two weeks of normal use for the drive units to settle. It is therefore recommended that you tighten the mounting bolts on each drive unit every few days during this period. Tighten the bolts in symmetrically opposite pairs using the 3mm hex wrench supplied.

You should then check and if necessary re-tighten the drive units every few years.

Removing the grilles (DSP7200)

The grilles are deliberately designed to fit tightly to avoid vibration during operation, and they should be removed using the following procedure to avoid damaging the loudspeaker.

The grille consists of elastic material stretched tightly over a plastic ring. The plastic ring includes two indentations at the three o'clock and nine o'clock positions, which you can locate by gently depressing the grille fabric.

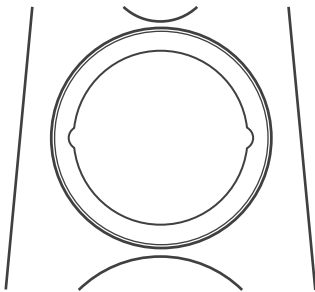

Hold the ring by one of the indentations by depressing the grille fabric with your thumb, and then wiggle the ring forwards until it comes free of the speaker. The grille fabric is very resilient and any depressions will soon disappear.

Note: On no account attempt to remove the grille with a hard object, or attempt to lever it out from the outside

edge, as you will damage the edge of the speaker surround and the grille itself.

Removing the grilles (DSP7200HC)

The DSP7200HC grille frame has been designed to be as acoustically transparent as possible, and is quite fragile. When removing the grille, ease it carefully off by hand from the four corners, avoiding excessive bending of the frame.

Note: On no account use a tool to remove the grille as this can scratch the cabinet or tear the grille fabric.

Specifications

Connections

- Digital co-axial input and output.
- Meridian BNC Comms input and output.
- Meridian SpeakerLink (RJ45) input and output, providing balanced digital and Meridian Comms.

Digital formats

- 44.1–96kHz. FIFO locks at 44.1, 48, 88.2, or 96kHz \pm 150ppm.
- PCM using IEC958, or MHR connection support with auto-detection.

Signal processing

- 1 x Motorola 56367 running at 150MHz.
- 4 x 24-bit Multi-bit delta-sigma DACs with 128x oversampling.
- Crossover linear-phase \pm 30° at 2.6kHz.

Output stages

- Power amplifiers: Complementary bipolar design, with output-stage error correction and twin loop design.
- Bass: 2 x 150W.
- Mid: 150W.
- Treble: 150W.
- Total: 600W.

Acoustic

- 3½ way.
- Ported bass enclosure.
- Isolated mid enclosure.
- Bass drive unit: 2 x 200mm (8") high-efficiency long-throw custom drivers.
- Mid drive unit: 1 x 160mm (6") custom polypropylene driver using phase plug.
- Treble drive unit: 1 x 25mm (1") Meridian piston in short horn, aluminium dome with silver voice-coil.

Characteristics

- Distortion typically <0.01%, or <0.02% up to full power at all frequencies.
- Noise and hum <-94dBr at all volume settings.
- Acoustic output typically >112dB spl @ 1m on music material.
- Acoustic noise <15dB spl @ 1m.
- Frequency response in room response within 3dB, 28Hz–20kHz.

Cabinet

- Entire speaker manufactured from interlaminated panels.
- Finished in high-gloss piano lacquer.
- 8-character display with system lights.
- DSP7200: 350mm x 1072mm x 415mm (13.8" x 42.2" x 16.3") (W x H x D).
- DSP7200HC: 1060mm x 295mm x 478mm (41.7" x 11.6" x 18.8") (W x H x D).
- DP7200: 55kg (121lb) each.
- DP7200HC: 64kg (141lb).

Power

- 100-125; 200-250V AC 50-60Hz.
- 20VA standby; 920VA max.

Meridian Audio reserves the right to amend product specifications at any time.

Connecting up the DSP loudspeakers

This chapter explains how you should connect your DSP loudspeakers to the other audio equipment in your system.

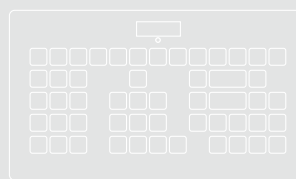

Connecting the loudspeakers

Back panel

The following diagram gives details of the back panel connections:

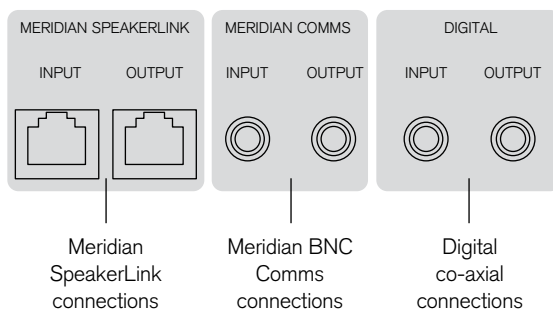

You can connect to the DSP loudspeakers using either the SpeakerLink connectors, or the Meridian BNC Comms and digital co-axial connectors.

Connecting using Meridian SpeakerLink

The Meridian SpeakerLink connectors provide both balanced digital and Meridian Comms control in a single SpeakerLink lead. The following table gives details of these connections:

Use this connection	To connect to this
MERIDIAN SPEAKER-LINK INPUT	A digital source with a Meridian SpeakerLink connector, such as a Meridian G Series digital sound processor, digital preamplifier, CD player, or DVD player.
MERIDIAN SPEAKER-LINK OUTPUT	A second (slave) DSP loudspeaker.

The digital connections should be made with SpeakerLink leads. Suitable cables are available from your Meridian dealer. Standard CAT5 computer cables may also be used.

We do not recommend the use of cables longer than 50 metres. Only connect the cables to the output of a Meridian product.

Connecting using the Meridian BNC Comms and digital co-axial connectors

The following table gives details of these connections:

Use this connection	To connect to this
MERIDIAN COMMS INPUT	The BNC COMMS connection on a Meridian control unit or preamplifier.
MERIDIAN COMMS OUTPUT	The BNC COMMS INPUT on a second DSP loudspeaker.
DIGITAL INPUT	A digital source such as a Meridian G Series digital sound processor, digital preamplifier, CD player, or DVD player.
DIGITAL OUTPUT	A second (slave) DSP loudspeaker.

The Comms connections should be made with BNC to BNC leads. Suitable cables are available from your Meridian dealer. Standard computer BNC to BNC cables may also be used.

The digital connections should be made with high-quality 75Ω screened cable. Suitable cables are available from Meridian. We do not recommend using audio cables, which do not have adequate shielding or the correct impedance, or cables intended for UHF applications, as these do not provide adequate shielding in the 1–30MHz region.

Connecting to other equipment

To connect two DSP loudspeakers to a Meridian product with SpeakerLink

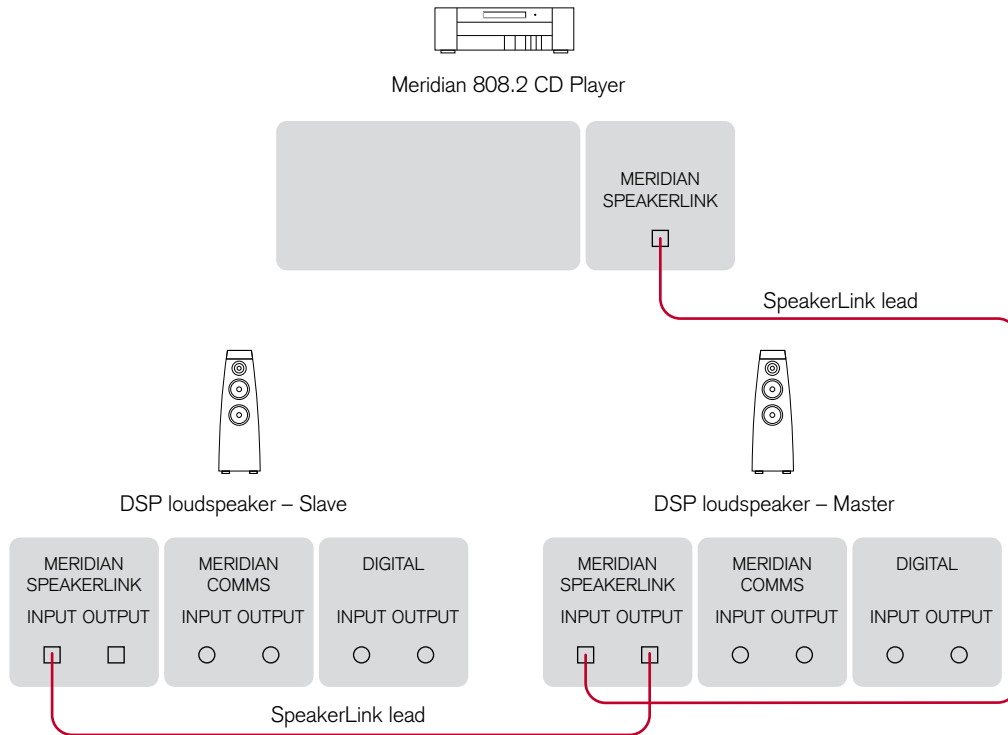

You can create a complete system by connecting a pair of DSP loudspeakers directly to a digital source. The DSP loudspeakers include volume, balance, and tone controls allowing you to control the system using the MSR+.

If the Meridian source or control unit includes a Meridian SpeakerLink output, such as the Meridian 808.2 CD Player, you can make all the connections using SpeakerLink leads.

- Connect the MERIDIAN SPEAKERLINK OUTPUT from the Meridian source or control unit to the MERIDIAN SPEAKERLINK INPUT on the DSP loudspeaker chosen as the master, using a SpeakerLink lead.
- Connect the MERIDIAN SPEAKERLINK OUTPUT from the master DSP loudspeaker to the MERIDIAN SPEAKERLINK INPUT on the other (slave) DSP loudspeaker, using a SpeakerLink lead.
- Configure the master DSP loudspeaker as **M.RJ45** and the slave DSP loudspeaker as **S.RJ45**; see *To choose master or slave and the primary connector*, page 34.

To connect two DSP loudspeakers to a Meridian product with BNC Comms

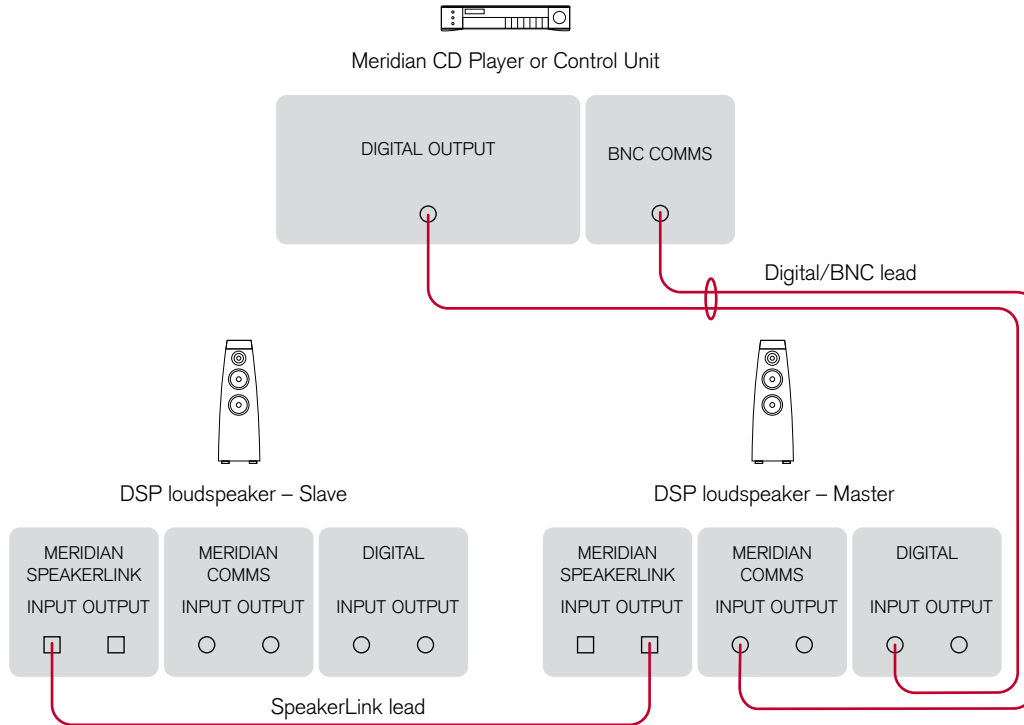

If the Meridian source or control unit provides a Meridian BNC Comms output, you will need to connect it to the DSP Loudspeakers using a Digital/BNC lead.

- Connect the DIGITAL OUTPUT and the BNC COMMS socket from the Meridian source or control unit to the DIGITAL INPUT and COMMS INPUT on the DSP loudspeaker chosen as the master, using a Digital/BNC lead.
- Connect the MERIDIAN SPEAKERLINK OUTPUT from the master DSP loudspeaker to the MERIDIAN SPEAKERLINK INPUT on the other (slave) DSP loudspeaker, using a SpeakerLink lead.
- Configure the master DSP loudspeaker as **M.Coax** and the slave DSP loudspeaker as **S.RJ45**; see *To choose master or slave and the primary connector*, page 34.

To connect three or more DSP loudspeakers in a Meridian surround system

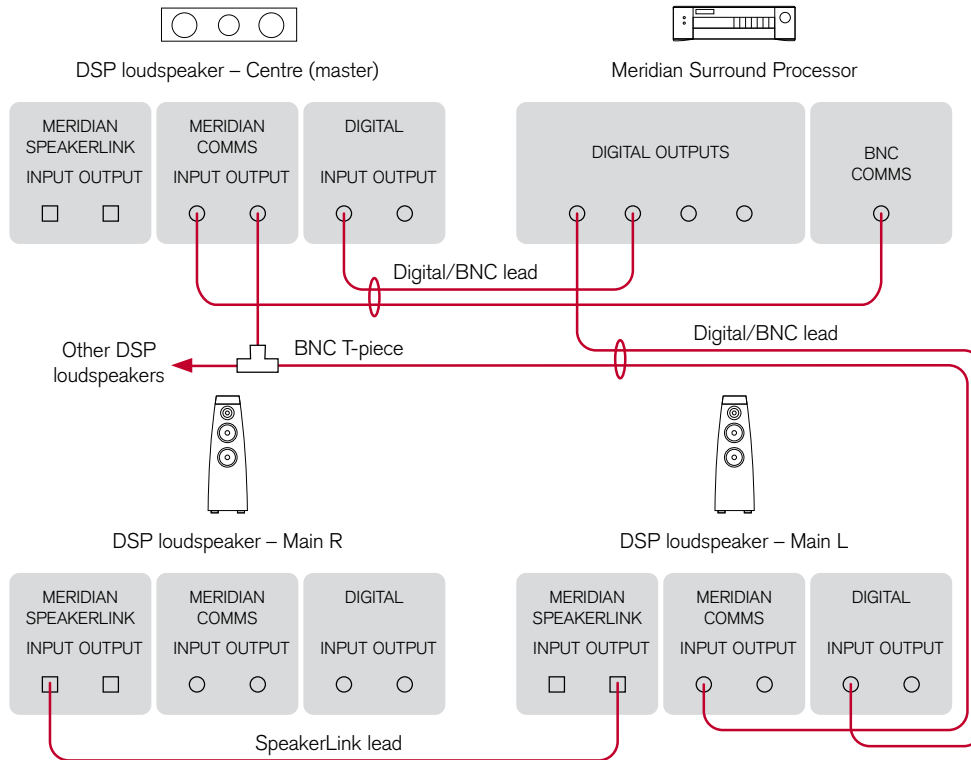

- Use the Comms part of a Digital/BNC lead to connect the BNC COMMS socket on the Meridian Surround Processor to the DSP loudspeaker you have chosen as the master (typically the centre speaker).
 - Use the audio part of the Digital/BNC lead to connect the appropriate digital output on the Meridian Surround Processor to the master DSP loudspeaker.
 - Connect each pair of DSP loudspeakers to the appropriate digital output on the Meridian Surround Processor, and to the BNC COMMS output from the master DSP loudspeaker, using a Digital/BNC lead.
 - Link each pair of DSP loudspeakers together using SpeakerLink leads, as shown in the illustration.
- If your system includes more than three DSP loudspeakers use BNC T-pieces to distribute the Comms to successive pairs of loudspeakers.
- Configure the centre DSP Loudspeaker as **M.Coax**, the Main L DSP loudspeaker as **S.Coax**, and the Main R DSP loudspeaker as **S.RJ45**; see *To choose master or slave and the primary connector*, page 34.

To use a DSP loudspeaker as a centre speaker

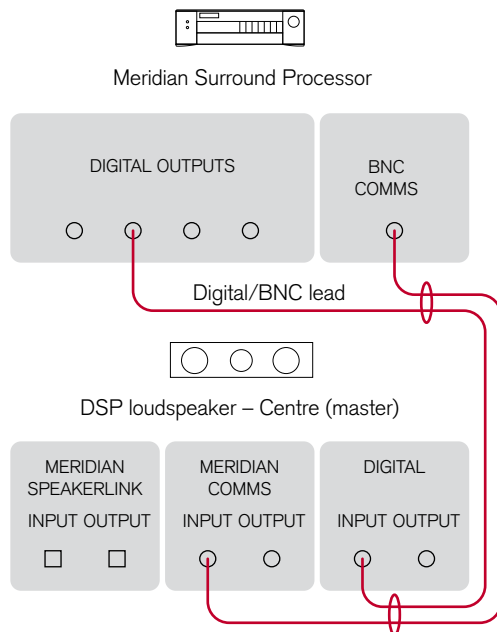

You can use a single DSP loudspeaker as a centre speaker in a Meridian surround system.

- Connect the speaker to the CENTRE digital output using a Digital/BNC lead, as shown in the illustration.
- Configure the centre DSP Loudspeaker as **M.Coax**; see *To choose master or slave and the primary connector*, page 34.

Positioning the digital loudspeakers

To obtain the best sound

For best results adjust the position of the loudspeakers while listening to music.

If possible, have the most acoustically absorbent wall in the room behind the front speakers. Ideally have each DSP loudspeaker at least 0.5m (20") from a corner, and position them approximately 0.25m (10") from the wall.

If you are using a DSP loudspeaker as a centre channel, place the speaker centrally between the main left-right pair and, if possible, arrange for the treble units of the three speakers to be approximately the same height.

You can configure the frequency response of the DSP loudspeakers to compensate for a position close to a wall or corner; see *To adjust the frequency response*, page 38.

Using the DSP loudspeakers

In systems with a Meridian preamplifier or control unit all of the functions of the DSP loudspeakers, including volume, treble, and bass, are operated via the controller. For more information refer to the user guide for the preamplifier or control unit, and you can ignore this chapter.

The DSP loudspeakers can also be connected directly to up to two digital sources to create a complete, minimum system. This chapter provides step-by-step instructions for operating the DSP loudspeakers in a system with no Meridian preamplifier or control unit.

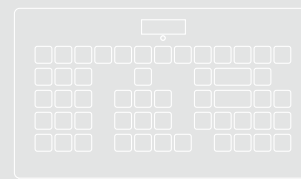

Selecting a source

When not playing, the DSP loudspeakers should be left in the standby state. This uses a negligible amount of electricity, but ensures that the components of the loudspeakers operate at maximum efficiency from the moment you start.

If you are not going to use the DSP loudspeakers for several days you should switch each unit completely off at the back panel, and disconnect it from the AC power supply.

To select a source

- Press the appropriate source key on the remote; eg **Radio**.

This will bring the DSP loudspeakers out of standby, and the displays will show the currently selected source and volume setting.

For example:



Initially all the sources are set to use the SpeakerLink digital input. To configure all sources to use the co-axial input, configure the speaker as **M.Coax** or **S.Coax**; see *To choose master or slave and the primary connector*, page 34. To configure an individual source to use a different input see *To configure a source*, page 37.

To switch to standby

- Press **Off** on the remote.

The displays will show:



Changing the display

The DSP loudspeakers display information about the current settings on the 8-character front-panel display.

In addition, three coloured indicators show status information.

To change the displayed information

- Press **Display**.

Pressing **Display** steps between the following options:

Display option	Example
Source and volume	Radio 65
Meridian source display (dashes if not present)	---
Audio format	PCM 96k
Blank	

The audio format display shows PCM, Data, or MHR followed by the frequency, or NL (not locked).

Status indicators

The display includes the following status indicators:

Indicator	Description
Red	Master loudspeaker.
Yellow	88kHz or 96kHz input.
Green	Clipping; see <i>Troubleshooting</i> , page 42.

Adjusting the volume

The DSP loudspeakers adjust the volume in precise steps of 1dB, where 9dB is equivalent to doubling the loudness, and can be varied in the range 1 to 99dB.

When you first connect power to the DSP loudspeakers the volume is set to 65, which is similar to the midway position of the rotary volume control on a conventional preamplifier.

To change the volume

- Press the ▲ or ▼ volume keys on the remote.

As you adjust the volume setting the display will show the current volume level.

For example:



Radio 55

To mute (silence) the sound

- Press **Mute** on the remote.

The display will show:



Muted

To restore the sound

- Press **Mute** again on the remote.

Changing the treble, bass, or phase

The DSP loudspeakers provide sophisticated treble and bass controls, to allow you to adjust the broad balance of the system to correct for the acoustics of your listening room, or for a misbalanced recording.

The controls are more subtle than conventional tone controls, and take advantage of digital signal processing techniques to provide a more natural adjustment of the frequency response.

You can also change the absolute phase of the signal, to compensate for signals which are out of phase, giving an unnatural-sounding bass.

If you have a Meridian Surround Controller these functions are performed via the surround controller.

To change the treble

- Press **Function** ◀ or **Function** ▶ until the display shows the current treble.

For example:

Tre. +0.0

- Press **Function** ▲ or **Function** ▼ to change the treble.

The treble control tilts the frequency of the response over the entire frequency range to make the sound brighter or dimmer. It can be adjusted between ± 10 db in 0.5dB steps. Normally settings between +1.0 and -2.0 will give the most natural results.

To change the bass

- Press **Function** ◀ or **Function** ▶ until the display shows the current bass setting.

For example:

Bass +0.0

- Press **Function** ▲ or **Function** ▼ to change the bass.

The bass control allows you to adjust the bass response in the room by ± 5 dB in 0.5dB steps. Normally settings between +3.0 and -2.0 will give the most natural results.

To change the absolute phase

- Press **Function** ▶ or **Function** ◀ until the display shows the current phase.

For example:

Phase +

- Press **Function** ▲ or **Function** ▼ to change the phase.

Changing the listening position

The balance control of the DSP loudspeakers uses digital signal processing to compensate for an off-centre listening position by delaying and diminishing the sound in one speaker, thus effectively shifting the speaker's image back.

The axis control allows you to adjust the optimum listening height of the DSP loudspeakers, like a balance control operating in the vertical plane.

listener will be below that position, so we recommend settings of -1 or -2.

If you have a Meridian Surround Controller these functions are performed via the surround controller.

To change the balance

- Press **Function** ◀ or **Function** ▶ on the remote until the display shows the current balance.

For example:

Bal. <0>

- Press **Function** ▲ or **Function** ▼ to change the balance.

The display shows the direction and position of the listening position.

For example:

Bal. 12>

- There are 32 steps in each direction.

To change the axis

- Press **Function** ◀ or **Function** ▶ on the remote until the display shows the current axis setting.

For example:

Axis -1

- Press **Function** ▲ or **Function** ▼ to change the axis.

The axis can be adjusted between 3 and -2, where 0 corresponds to the axis of the treble unit. Usually a

Configuring the DSP loudspeakers

This chapter explains how to configure the DSP loudspeakers to suit the other equipment in your system.

The first stage in configuring the DSP loudspeakers is to choose one of the standard settings, and these are designed to set all of the parameters to their most common values. You can also configure each setting individually for applications not catered for by one of the standard settings.

Once you have configured the DSP loudspeakers you will probably never need to change the configuration, unless you alter the equipment connected to your system at a later stage.

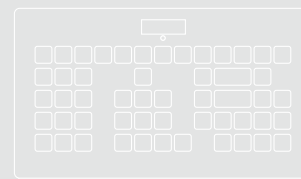

Choosing standard settings

The DSP loudspeakers provide the following five alternative standard settings, called Types, which configure all aspects of the DSP loudspeakers into the most commonly needed configurations:

Type	Description
1	Standard setting for 2-channel system.
5	For use with a Meridian CD player (eg 808.2) connected to the SpeakerLink input; all other sources use the co-axial input.
6	For use with a Meridian Surround Controller.
7	For use in a second room.
8	For use in the second or third room of a three-room system.

Types 2, 3, and 4 are for compatibility with 200/600 series units.

In all cases except Type 5, the D1 input is used for all sources.

Choosing one of the standard settings overrides any other configuration you may have performed, and so can be used to reset the configuration of the speakers.

To select a standard setting

- Switch off the DSP loudspeaker.
- Turn on the power again while holding down the number key on the remote which corresponds to the Type you want to use.

The display will show the Type number.

For example:



- Release the remote key.

The display will show:



You should now specify the speaker's position as follows.

To specify the speaker position

- Press ▲ or ▼ to specify the speaker position.

The options are shown in the following table:

Display	Position
L.	Left.
R.	Right.
C.	Centre (Type 6 only).

To choose master or slave and the primary connector

You should select one loudspeaker to be the master; this will normally be the centre channel. For more information see *Connecting to other equipment*, page 21. Each other DSP loudspeaker should be configured as a slave.

- Press the green ► (Play) key on the remote.
- For each speaker this steps between the following four options:

Option	Master/slave	Primary input
M.RJ45	Master	Meridian SpeakerLink
M.Coax	Master	Digital co-axial
S.RJ45	Slave	Meridian SpeakerLink
S.Coax	Slave	Digital co-axial

Initially all sources will be configured to use the primary input you have specified, but you can configure individual sources to use the other input; see *To configure a source*, page 37.

For example, to define the left speaker as a slave using the digital co-axial connectors:

The display shows:

A digital display showing the text "L.S.Coax" in a pixelated font.

When you have configured the loudspeaker:

- Switch off the DSP loudspeaker, using the power switch on the back, and then switch on again to restore normal operation.

Specifying information about your system

You can configure the operation of the DSP loudspeakers to suit the way your system is set up, and the way in which you want to use it. These settings are configured automatically to appropriate values when you choose one of the standard Type settings, and you should not normally need to alter them; see *Choosing standard settings*, page 34.

To configure the DSP loudspeaker

- Turn off the DSP loudspeaker, using the power switch on the back panel.
- Turn on the power again while holding down the **0** key on the remote.

The display will show the current setting of the first configuration option.

For example:

L.M.RJ45

- Press **▶** or **◀** to step between the options.
- Press **▲** or **▼** to change the value of the current option.

The following table shows the options you can configure:

Option	Initial value in Type 1
Position and master/slave	L.
Compatibility (G, 500, 200 Pre, or 200 CD)*	G
Controller mode (Auto, Con, or NCon)	Auto
System address (1–8)	S.A. 1
Product address (1–8)	P.A. 1
Volume mode (1=normal, 2/3=second or additional room)	L.E. 1
Balance control (N or Y)	Bal. Y
Centre menus? (N or Y)	Centre N
Diagnostic displays? (N or Y)	Dias. N

* G gives 500 Comms and MSR+ sources, 500 gives 500 Comms and MSR sources, and 200 Pre or 200 CD are legacy modes.

Configuring the sources

The DSP loudspeakers provide 12 sources corresponding to the 12 source selection keys on the remote:

CD, RADIO, DVD, AUX, DISC, TAPE, TV, CABLE, SAT, VCR1, VCR2, and GAME.

When the master DSP loudspeaker is set to one of the standard Types, the source selection keys select the co-axial input (apart from Type 5 which assigns the CD source to the SpeakerLink input). See *Choosing standard settings*, page 34.

If the configuration you want is not catered for by one of the standard settings, you can configure each source individually.

For each source you can configure:

- The label used for it on the front panel display, from a range of alternative labels.
- The digital input it selects.
- The comms type and address, to control other Meridian 500 Series equipment.
- Other advanced options.

You only need to configure the sources on the DSP loudspeaker you have specified as the master.

To configure a source

While in configuration mode:

- Press the source key on the remote corresponding to the source you want to configure.

For example, to configure the Radio source press **RADIO**.

The display shows:

RD Radio

- Press ► or ◀ to step between options.

The right-hand set of characters shows the current value of the option.

- Press ▲ or ▼ to change the value of the option.

When you have finished programming sources:

- Switch off at the back panel, and then switch on again to restore normal operation.

The options are summarised in the table below:

Option	Initial value	Alternatives	Explanation
Label	Radio	CD, Radio, LP, etc.	The label used to identify the source on the front panel display.
Audio input	D1	D1 or D2.	Choose D1 for the input configured as the primary connector, or D2 for the other input.
Comms type	2C	1C – 9C, or NC.	Choose 1C for a Meridian CD player, 2C for a Meridian FM Tuner, 3C for a Meridian DVD player, or NC otherwise.
Address	1A	1A – 8A.	Choose 1A unless you have several Meridian products of the same Comms type.
FIFO	FF. Y	Y or N.	Choose N to disable the FIFO buffer if you have difficulty locking to a poor source.

Configuring the setup options

The setup options allow you to adjust the frequency response of the loudspeakers to compensate for their position. You only need to configure the master loudspeaker.

When configuring the DSP loudspeakers, point the remote at the speakers, even if you have a Meridian Surround Controller.

To select Setup mode

- Turn off the DSP loudspeaker using the power switch on the back panel.
- Turn on the power again while holding down the **Store** key on the remote.

The display will show:



It will then revert to standby:

The display shows:



You can now operate the speaker in the usual way, using the additional setup menus to adjust the response while listening to sources.

When you have finished adjusting the setup options:

- Switch off at the back panel, and then switch on again to restore normal operation with the setup you have programmed.

To adjust the frequency response

- Press **Function** ► or **Function** ◀ until the display shows the current response setting.

For example:



- Press **Function** ▲ or **Function** ▼ to select the appropriate option as follows:

Option	What it means
Free	Flat frequency response.
Boundary	Speaker closer than 0.5m (20") to a wall.
Sub . 1	Applies a second-order high-pass filter at 80Hz for use with an analogue subwoofer.
Sub . 2	Applies a second-order high-pass filter at 120Hz for use with an analogue subwoofer
Corner	Speaker closer than 0.5m (20") to a corner.

To adjust the centre frequency response and tilt offset

If your system includes a DSP centre speaker you should set **Centre Y** on the master speaker. An additional frequency response option is then provided to allow you to adjust the centre speaker, with the options:

C.Free, **C.Boun.**, **C.Sub 1**, **C.Sub 2**, and **C.Corner**.

- Press **Function ▶** or **Function ◀** until the display shows the current centre frequency response.

For example:

C. Free

- Press **Function ▲** or **Function ▼** to select the appropriate option for the centre speaker.

An additional centre tilt offset option is also provided. The centre tilt offset is added to the treble value for the selected source. The recommended setting is -1dB when the speaker is positioned above a television.

- Press **Function ▶** or **Function ◀** until the display shows the current centre tilt offset.

For example:

C. Tilt+1

- Press **Function ▲** or **Function ▼** to adjust the centre tilt offset.

To store the settings

Once you have adjusted the frequency response for the speakers in your system you should store the settings using the following procedure:

- Press **Function Store**.

The display shows:

Store

- Turn off the DSP loudspeaker using the power switch on the back panel.

When you turn on the power again the speaker will operate normally with the frequency response settings you have stored.

Troubleshooting

This chapter provides suggested solutions to typical problems that may occur when setting up the DSP loudspeakers.

If you are still not able to resolve a difficulty with the help of this guide and the suggestions in the following pages, please contact your Meridian dealer or Meridian Audio Ltd.

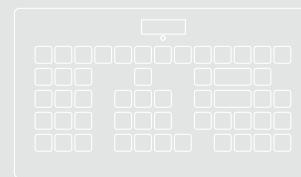

Troubleshooting

Display on front panel not lit

Check the following:

- There is AC power connected to the socket on the back of the DSP loudspeaker.
- The power switch on the back panel of the DSP loudspeaker is turned on.

If the display will still not illuminate, check any fuses in your power supply and the fuse in the inlet of the DSP loudspeaker. If these are all intact, contact your dealer.

Unit stays in standby

- Check that it is connected correctly.
- Turn the system on from another Meridian product in the system.

Remote not working

Check the following:

- The battery in the MSR+ remote.
- See if the DSP loudspeaker has been set up as not controller in the Meridian Configuration program; see Configuring the setup options, page 38. Note: This may be deliberate by your dealer.

Configuring the DSP loudspeaker does not have any effect

Make sure that you are configuring the DSP loudspeaker used as the master digital loudspeaker in the system. This determines the configuration of all digital loudspeakers in the system.

Drive units move when the speaker is switched on or off

This is normal as the speaker active electronics settle.

Only the master loudspeaker plays

- Check the cables are connected correctly.

There is radio interference

The DSP loudspeaker is a digital audio and computing device which has been designed to very high standards of electromagnetic compatibility.

If this equipment does cause or suffer from interference to/from radio or television reception then the following measures should be tried:

- Reorient the receiving aerial (or antenna) or route the antenna cable of the receiver as far as possible from the DSP loudspeaker and its cabling.
- Ensure that the receiver uses well-screened antenna cable.
- Relocate the receiver with respect to the DSP loudspeaker.
- Connect the receiver and this product to different AC outlets.
- If the problem persists contact your dealer.

Sound is odd or mono

- Check that the DSP loudspeakers are correctly configured as Left and Right respectively.

Unit goes silent when played hard and displays 'Hot'

The DSP loudspeakers have a temperature sensing system on board, which prevents overheating of the electronics. The sound will continue when the speaker has cooled.

The green indicator flashes or stays on

This indicates that DSP clipping is occurring.

Brief flashes indicate occasional clipping which will not be audible.

If the indicator stays on for long periods this may indicate a fault in the configuration of your system, and you should contact your Meridian dealer.

Cleaning

Cleaning

Small marks on the lacquer surface can usually be removed with a damp cloth.

Deeper scratches can be removed by treating with additional polyester lacquer filler and then polishing carefully. Consult your authorised Meridian dealer for advice before attempting any repair.

Service and guarantee

Service

The Meridian components have been carefully designed to give years of untroubled service. There are no user-serviceable parts inside the case, nor do the units require any form of maintenance, apart from tightening the drive units as described in this user guide.

In the unlikely event that your DSP loudspeaker fails to function correctly, it should be returned, in its original packaging, to your Meridian dealer.

In case of difficulty within the UK or USA please contact the appropriate sales and service address shown on page iv.

In case of difficulty outside the UK or USA, contact the importing agent for the territory. A list of Meridian agents abroad is available from Meridian Audio.

No responsibility can be accepted for the DSP loudspeakers whilst in transit to the factory or an agent, and customers are therefore advised to insure the unit. When seeking service under guarantee, proof of the date of purchase will be required.

Guarantee

Each DSP Digital Loudspeaker System is guaranteed against defects in material and workmanship for two years from the date of purchase.

The guarantee is void if the DSP Digital Loudspeaker System has been subject to misuse, accident, or negligence, or has been tampered with or modified in any way without the written authorisation of Meridian Audio Limited. **Note:** Connecting anything other than the correct network lead to the Comms or SpeakerLink sockets may cause damage to the DSP Digital Loudspeaker System which will not be covered by this guarantee. Attempted servicing by unauthorised people may also invalidate this guarantee. Labour and carriage charges are not covered unless by local agreement.

Outside the UK, local warranty liability is restricted to equipment purchased within the territory. Our agents abroad are only under contractual obligation to service under guarantee equipment sold through them. They are entitled to make a non-refundable charge for any service carried out on other equipment.

This guarantee does not limit your statutory rights within the United Kingdom.

Index

A

- absolute phase, changing 31
- accessories 3
- axis, changing 32

B

- balance, changing 32
- bass, changing 31
- BNC Comms 20
 - configuring 34
 - connecting with 22

C

- cabinet 2
- centre frequency response,
 - configuring 39
- centre speaker, connecting 24
- centre tilt offset, configuring 39
- cleaning 43
- communications connections 20
- configuration options 36
- configuring setup options 38
- configuring sources 37
- connecting the loudspeakers 20
- connecting to other equipment 21
- connections
 - digital co-axial 20
 - Meridian Comms 20
 - SpeakerLink 20

D

- digital connections 20
 - configuring 34

- display, changing 29
- DSP5200 and DSP5200HC 7
- DSP5500, DSP5500HC, and
 - DSP5500C 11
- DSP7200 15

F

- feet, fitting
 - DSP5200 8
 - DSP5500 and DSP5500C 12
- frequency response, configuring 38

G

- grilles, removing
 - DSP5200 and DSP5200HC 9
 - DSP5500, DSP5500HC, and
 - DSP5500C 13
 - DSP7200 and DSP7200HC 17
- guarantee 44

L

- lacquer finish 8, 16
- listening position, changing 32

M

- master
 - configuring 36
 - specifying 34
- Meridian Comms 3
- Meridian Comms input 20
- Meridian Comms output 20
- Meridian Digital Music System 5
- Meridian Digital Theatre™ 4

- Meridian High Resolution (MHR) 3
- mounting options 3
- muting the sound 30

P

- phase, changing 31
- power amplifiers 2

R

- remote, troubleshooting 42
- rubber bumpons, fitting
 - DSP5200HC 9
 - DSP5500HC 12

S

- safety warnings ii
- sample configurations
 - Meridian Digital Music System 5
 - Meridian Digital Theatre™ 4
- selecting a source 28
- service 44
- settings, storing 39
- setup options, configuring 38
- slave
 - configuring 36
 - specifying 34
- sources
 - configuring 37
 - selecting 28
- SpeakerLink 20
 - configuring 34
 - connecting with 21
- speaker position, configuring 38

specifications

DSP5200 and DSP5200HC 10

DSP5500, DSP5500HC, and
DSP5500C 14

DSP7000 and DSP7200HC 18

standard settings, configuring 34

standby, switching to 28

status indicators 29

storing settings 39

switching to standby 28

T

tightening the drive units

DSP5200 and DSP5200HC 9

DSP5500, DSP5500HC, and
DSP5500C 12

DSP7200 and DSP7200HC 16

tilt offset, configuring 38, 39

treble, changing 31

troubleshooting 41

U

unpacking

DSP5200 and DSP5200HC 8

DSP5500, DSP5500HC, and
DSP5500C 12

DSP7000 16

V

volume

adjusting 30

muting 30